



Standard models  
in top quality



# Zuluna

„Enter our world...



... of fascinating designs for everyone”

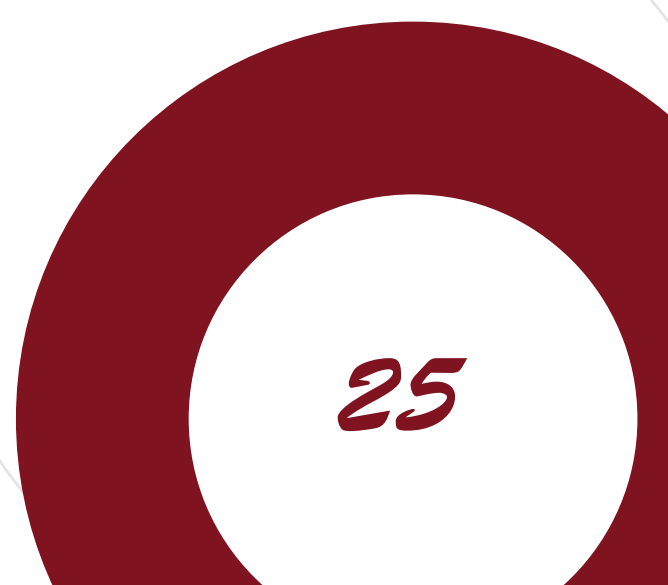

25



## ■ Zuluna range is not limited to log cabins for warm weather only.

Be surprised by versatility of our products! Discover our range of high quality buildings and let yourself be inspired!



## ■ About us

Dear Customers, for more than 20 years we manufacture top quality, unique wooden products in almost all variants, now with pre-assembled wall panels with weather resistant cladding.

Coniferous timber used by us is sourced from north Scandinavian woods, free from discoloration, blue spots and only with few healthy knots; it is dried to moisture levels approx. 16%. As per motto „if you stop wanting to get better, you stop being good” we aim to create buildings as per customers’ wishes. Let yourself be inspired to design your own building.

If you cannot find a model for your needs, we are able to create a bespoke building as per your requirements.

We wish you much joy in realizing your own dreams.

## ■ Contents

Garden buildings	5
Sheds	27
Garden saunas	33
Carports	39
Gazebos	41
Sales kiosks	43
Side roofs	44
More information	46
Accessories	50
Base	51

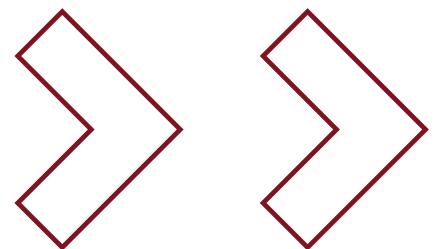

# Follow these steps to fulfill your dream



**1** Choose a model



**2** Add accessories



**3** Raw material



**4** Manufacturing



**5** Transport



**6** Assembly



**7** End result





# GARDEN BUILDINGS



## H45PLUS-3842-2ET-DF-EF

Wall log thickness	45 mm
Sizes (width / depth)	380 x 420 cm
Side wall height	244,8 cm
Max. height	326,5 cm
Roof overhangs (F/B/L/R)	120, 20, 25, 25 cm
Roof slope direction	23°
Doors	2 x ET 84 x 194 cm
Windows	2 x EF 75 x 92, DF 110 x 92 cm

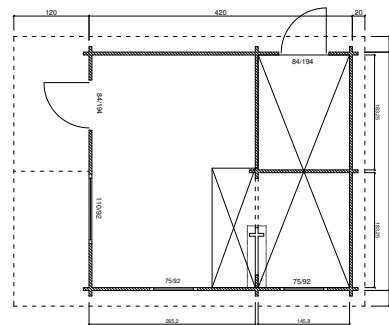

Object ID 46



## H28-2420-DT ALSO AVAILABLE IN DIFFERENT SIZES

Wall log thickness	28 mm
Sizes (width / depth)	240 x 200 cm, 240 x 240 cm, 240 x 300 cm
Side wall height	201 cm
Max. height	236 cm
Roof overhangs (F/B/L/R)	40, 20, 25, 25 cm
Roof slope direction	15°
Doors	DT 150 x 184 cm

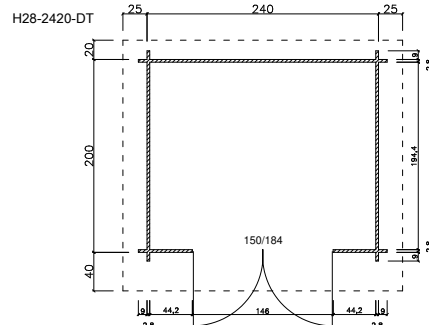

Object ID 661



**H28-2420-ET-EF** ALSO AVAILABLE IN DIFFERENT SIZES

Wall log thickness	28 mm
Sizes (width / depth)	240 x 200 cm, 240 x 240 cm, 240 x 300 cm
Side wall height	201 cm
Max. height	236 cm
Roof overhangs (F/B/L/R)	40, 20, 25, 25 cm
Roof slope direction	15°
Doors	ET 150 x 184 cm
Windows	EF 75 x 92

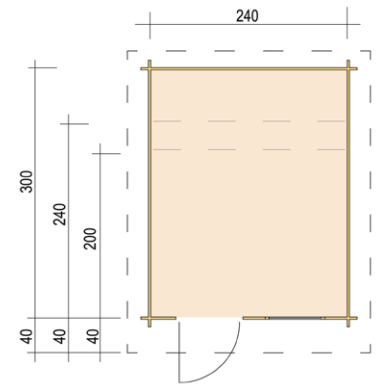

Object ID 77



**H28-2420F-DT-EF** ALSO AVAILABLE IN DIFFERENT SIZES

Wall log thickness	28 mm
Sizes (width / depth)	240 x 200 cm, 240 x 240 cm
Side wall height	218 cm
Max. height	212 cm
Roof overhang (all around)	25 cm
Roof slope direction	2°
Doors	ET 150 x 184 cm
Windows	EF 100 x 40 cm

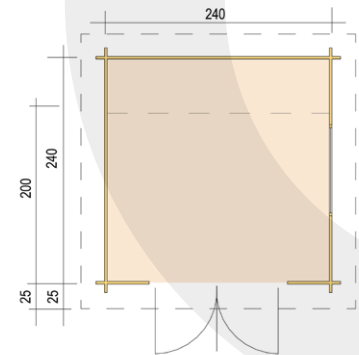

Object ID 85



**H28-3024-DT** ALSO AVAILABLE IN DIFFERENT SIZES

Wall log thickness	28 mm
Sizes (width / depth)	300 x 200 cm, 300 x 240 cm, 300 x 300 cm
Side wall height	201 cm
Max. height	245 cm
Roof overhangs (F/B/L/R)	70, 20, 25, 25 cm
Roof slope direction	15°
Doors	T 150 x 184 cm

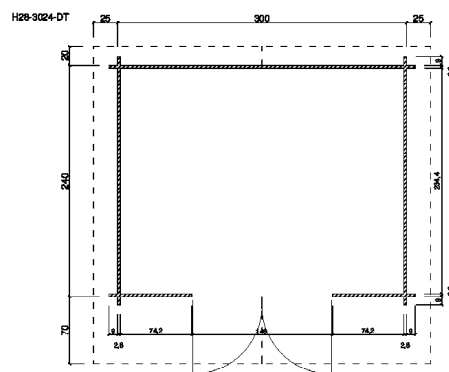

Object ID 665



**H28-3020-ET-EF** ALSO AVAILABLE IN DIFFERENT SIZES

Wall log thickness	28 mm
Sizes (width / depth)	300 x 200 cm, 300 x 240 cm, 300 x 300 cm
Side wall height	201 cm
Max. height	245 cm
Roof overhangs (F/B/L/R)	40 (70), 20, 25, 25 cm
Roof slope direction	15°
Doors	ET 84 x 184 cm
Windows	ET 75 x 92 cm

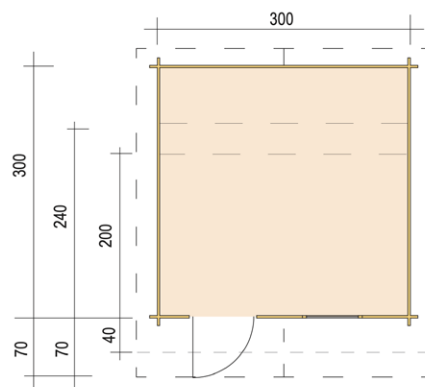

Object ID 80



**H28-3020F-DT-EF** ALSO AVAILABLE IN DIFFERENT SIZES

Wall log thickness	28 mm
Sizes (width / depth)	300 x 200 cm, 300 x 240 cm, 300 x 300 cm
Wall height (front)	218 cm
Wall height (back)	212 cm
Roof overhang (all around)	25 cm
Roof slope direction	2°
Doors	DT 150 x 184 cm
Windows	EF 100 x 40 cm

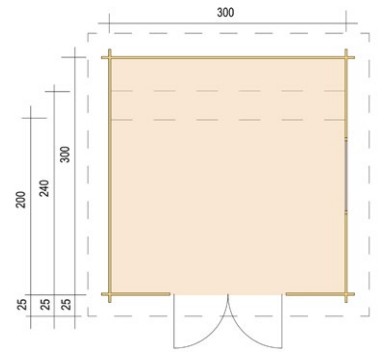

Object ID 87



**H28-3020P-DT** ALSO AVAILABLE IN DIFFERENT SIZES

Wall log thickness	28 mm
Sizes (width / depth)	240 x 200 cm, 240 x 240 cm, 300 x 300 cm
Wall height (front)	234 cm
Wall height (back)	201 cm
Roof overhang (all around)	30 cm
Roof slope direction	10°, 8°, 6°
Doors	DT 150 x 184 cm
Shown model includes additional accessories	

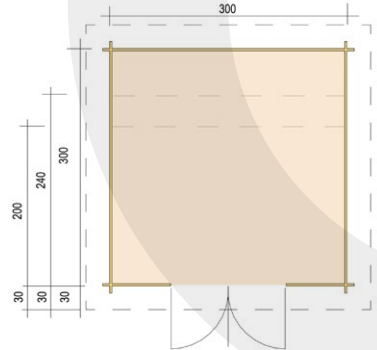

Object ID 90





## H28-3030-DT-2FT-EF

Wall log thickness 28 mm  
 Sizes (width / depth) 300 x 300 cm  
 Side wall height 209 cm  
 Max. height 278 cm  
 Roof slope direction 25°  
 Doors DT 140 x 194, 2 x FT 50 x 194 cm

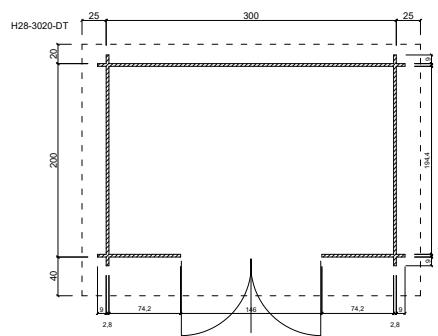

Object ID 1527



## H28-3046+300FS-DT-ET-EF

Wall log thickness 28 mm  
 Sizes (width / depth) 300 + 300 x 460 cm  
 Side wall height 220 cm  
 Max. height 267,8 cm  
 Roof overhangs (F/B/L/R) 25 cm  
 Roof slope direction 18°  
 Doors DT 150 x 194, ET 84 x 194 cm  
 Windows EF 75 x 92 cm

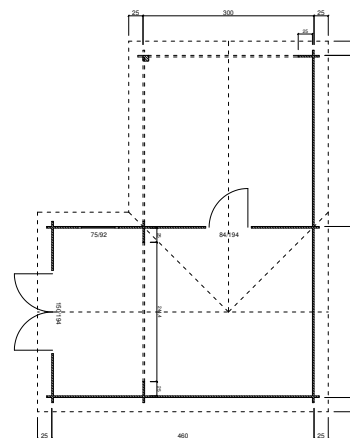

Object ID 45



**H28-3830-DT-EF** ALSO AVAILABLE IN DIFFERENT SIZES

Wall log thickness	28 mm
Sizes (width / depth)	380 x 300 cm, 380 x 380 cm
Side wall height	201 cm
Max. height	254 cm
Roof overhangs (F/B/L/R)	70, 20, 25, 25 cm
Roof slope direction	15°
Doors	DT 150 x 184 cm
Windows	EF 75 x 92 cm

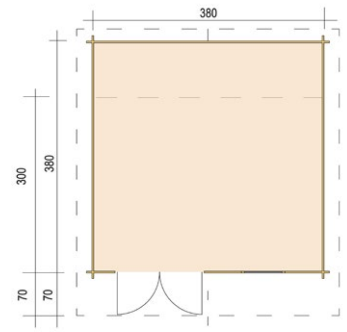

Object ID 83



**H28-3842-2ET-EF**

Wall log thickness	28 mm
Sizes (width / depth)	380 x 420 cm
Wall height (front)	212 cm
Wall height (back)	268 cm
Sizes (width / depth)	70, 20, 25, 25 cm
Roof slope direction	15°
Doors	2 x ET 84 x 184 cm
Windows	3 x EF 75 x 92 cm

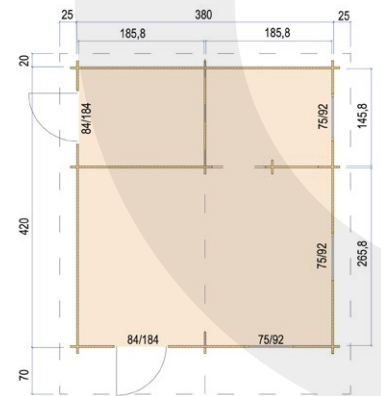

Object ID 75



## H28-4230-ET-EF

Wall log thickness	28 mm
Sizes (width / depth)	420 x 300 cm
Side wall height	201 cm
Max. height	256 cm
Roof overhangs (F/B/L/R)	70, 20, 25, 25 cm
Roof slope direction	15°
Doors	2 x ET 84 x 184 cm
Windows	2 x EF 75 x 92 cm

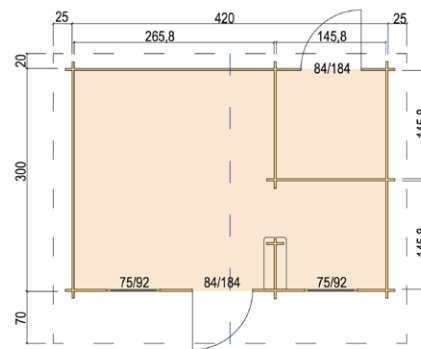

Object ID 76



## H45 3949+320FS-2DT-3EF

Wall log thickness	45 mm
Sizes (width / depth)	390 + 320 x 490 cm
Side wall height	244,8 cm
Max. height	250,6 cm
Roof overhang (all around)	10,8 cm
Roof slope direction	2°
Doors	2 x DT 176 x 200 cm
Windows	3 x EF 70 x 197 cm

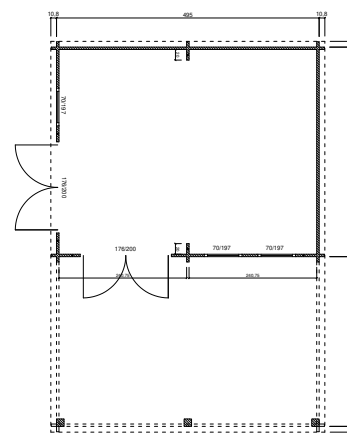

Object ID 42



**H45-3024F-DT-EF + SD**

Wall log thickness	45 mm
Sizes (width / depth)	240 x 300 cm
Wall height (front)	225 cm
Wall height (back)	218 cm
Roof overhang (all around)	25 cm
Roof slope direction	2°
Doors	DT 150 x 194 cm
Windows	EF 100 x 40 cm

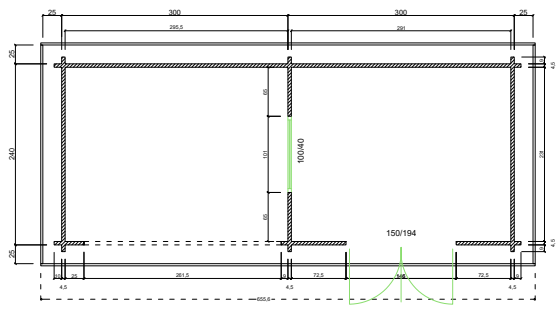

Object ID 1390



**H45-3030-DT**

Wall log thickness	45 mm
Sizes (width / depth)	300 x 300 cm
Side wall height	207 cm
Max. height	257 cm
Roof overhangs (F/B/L/R)	120, 20, 25, 25 cm
Roof slope direction	18°
Doors	DT 150 x 194 cm
Shown model includes additional accessories.	

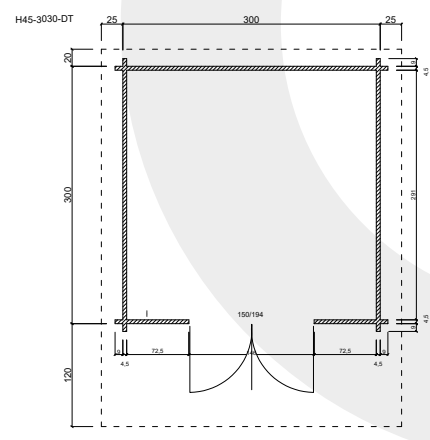

Object ID 667



## H45-3030-ET-EF

Wall log thickness	45 mm
Sizes (width / depth)	300 x 300 cm
Side wall height	207 cm
Max. height	257 cm
Roof overhangs (F/B/L/R)	120, 20, 25, 25 cm
Roof slope direction	18°
Doors	ET 84 x 194 cm
Windows	EF 75 x 92 cm

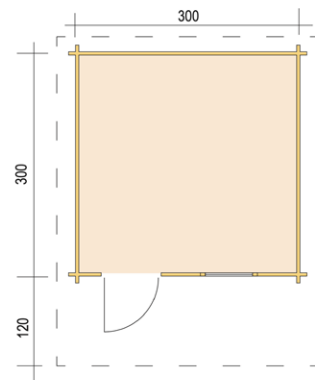

Object ID 93



## H45-3630-DT-EF ALSO AVAILABLE IN DIFFERENT SIZES

Wall log thickness	45 mm
Sizes (width / depth)	360 x 300 cm, 360 x 360 cm
Side wall height	207 cm
Max. height	267 cm
Roof overhangs (F/B/L/R)	120, 20, 25, 25 cm
Roof slope direction	18°
Doors	DT 150 x 194 cm
Windows	EF 75 x 92 cm

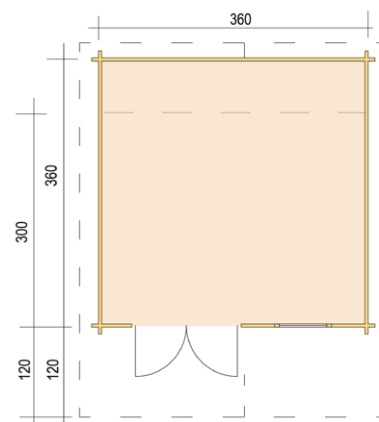

Object ID 94



**H45-3930-DT-EF** ALSO AVAILABLE IN DIFFERENT SIZES

Wall log thickness	45 mm
Sizes (width / depth)	390 x 300 cm, 390 x 390 cm
Side wall height	207 cm
Max. height	272 cm
Roof overhangs (F/B/L/R)	120, 20, 25, 25 cm
Roof slope direction	18°
Doors	DT 150 x 194 cm
Windows	EF 75 x 92 cm

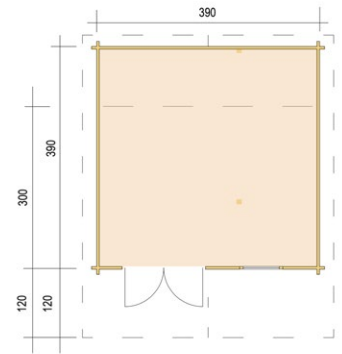

Object ID 97



**H45-3939-DT-EF**

Wall log thickness	45 mm
Sizes (width / depth)	390 x 390 cm
Side wall height	207 cm
Max. height	272 cm
Roof overhangs (F/B/L/R)	120, 20, 25, 25 cm
Roof slope direction	18°
Doors	DT 150 x 194 cm
Windows	EF 75 x 92 cm

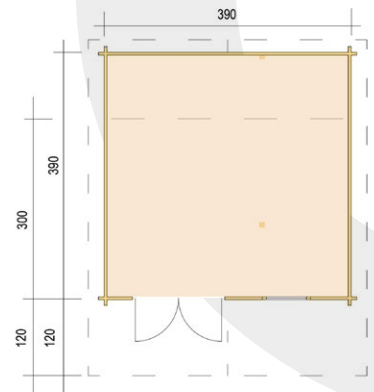

Object ID 98





**WE REALIZE  
YOUR DREAMS**



### H45-4024F-DT-EF

Wall log thickness	45 mm
Sizes (width / depth)	400 x 240 cm
Wall height (front)	225 cm
Wall height (back)	218 cm
Roof overhang (all around)	25 cm
Roof slope direction	2°
Doors	DT 150 x 194 cm
Windows	EF 100 x 40 cm

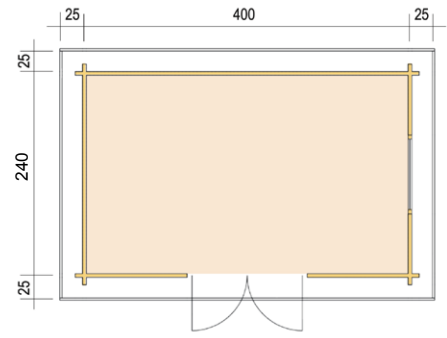

Object ID 96



### H45-4839-DT-DF ALSO AVAILABLE IN DIFFERENT SIZES

Wall log thickness	45 mm
Sizes (width / depth)	485 x 390 cm, 485 x 485 cm
Side wall height	207 cm
Max. height	287 cm
Roof overhangs (F/B/L/R)	120, 20, 25, 25 cm
Roof slope direction	18°
Doors	DT 150 x 194 cm
Windows	EF 110 x 92 cm

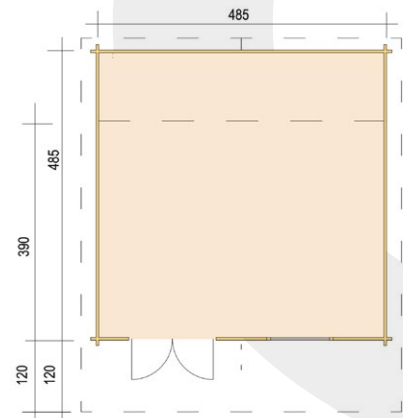

Object ID 100







### H45PLUS 3842-2ET-EF

Wall log thickness	45 mm
Sizes (width / depth)	380 x 420 cm
Side wall height	248 cm
Max. height	328 cm
Roof overhangs (F/B/L/R)	120, 20, 25, 25 cm
Roof slope direction	23°
Doors	2 x ET 84 x 194 cm
Windows	3 x EF 75 x 92 cm

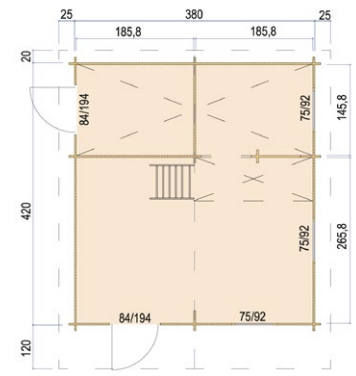

Object ID 99



### H45PLUS 4238-DT/ET-EF

Wall log thickness	45 mm
Sizes (width / depth)	420 x 380 cm
Side wall height	248 cm
Max. height	328 cm
Roof overhangs (F/B/L/R)	120, 20, 25, 25 cm
Roof slope direction	23°
Doors	DT 150 x 194; ET 84 x 194 cm
Windows	EF 75 x 92 cm

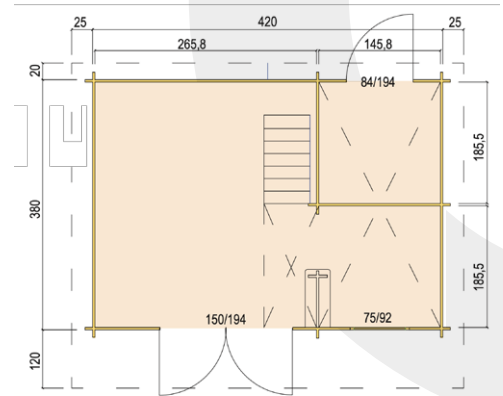

Object ID 102



## MHH-3025-P

Wall log thickness	15 mm
Sizes (width / depth)	300 x 250 cm
Max. height	257 cm
Roof overhangs (F/B/L/R)	25 cm
Roof slope direction	10°
Doors	ET 84 x 194 cm
Windows	EF 75 x 92 cm

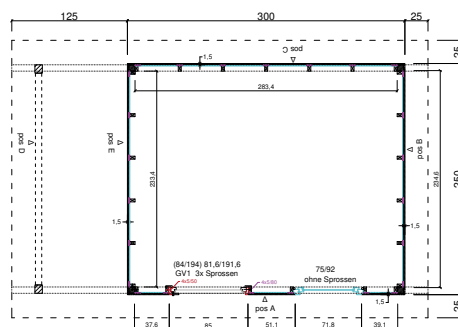

Object ID 1002



## TS-H28-2119-DT ALSO AVAILABLE IN DIFFERENT SIZES

Wall log thickness	28 mm
Sizes (width / depth)	210 x 190 cm
Side wall height	190 cm
Max. height	231 cm
Roof overhangs (F/B/L/R)	30, 20, 20, 20 cm
Roof slope direction	20°
Doors	DT 142 x 184 cm

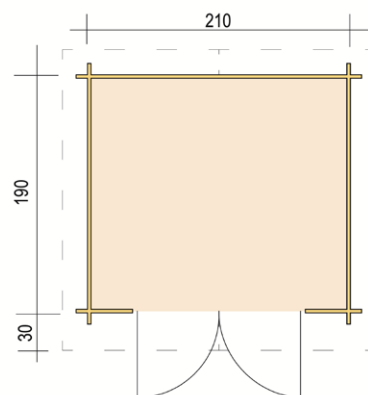

Object ID 64



**TS-H28-2424-DT**

Wall log thickness	28 mm
Sizes (width / depth)	240 x 240 cm
Side wall height	190 cm
Max. height	236 cm
Roof overhangs (F/B/L/R)	40, 20, 20, 20 cm
Roof slope direction	20°
Doors	DT 142 x 184 cm

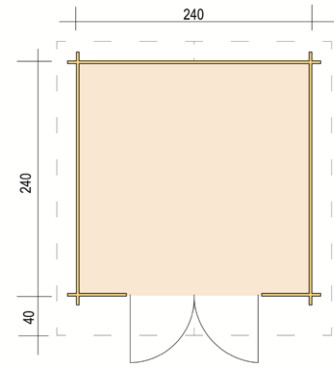

Object ID 65



**TS-H28-2828-5P-DT**

Wall log thickness	28 mm
Sizes (width / depth)	280 x 280 cm
Side wall height	212 cm
Max. height	291 cm
Roof overhang (all around)	25 cm
Roof slope direction	25°
Doors	DT 142 x 184 cm
Windows	2 x EF 75 x 92 cm

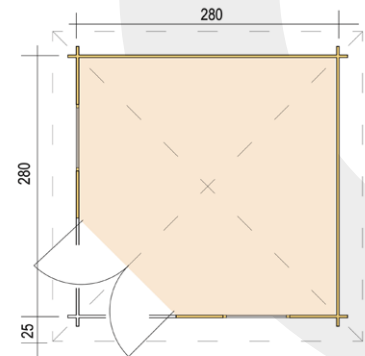

Object ID 70



**TS-H28-3024-DT** ALSO AVAILABLE IN DIFFERENT SIZES

Wall log thickness 28 mm  
 Sizes (width / depth) 300 x 240 cm, 300 x 300 cm  
 Side wall height 190 cm  
 Max. height 247 cm  
 Roof overhangs (F/B/L/R) 40, 20, 20, 20 cm  
 Roof slope direction 20°  
 Doors DT 142 x 184 cm  
 Shown model includes additional accessories.

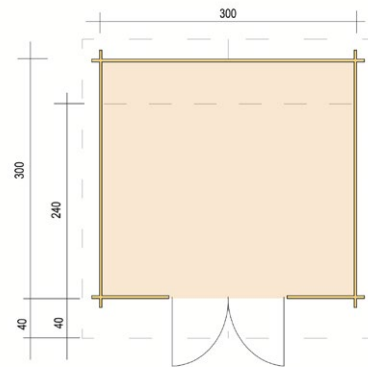

Object ID 66



**TS-H28-3024-ET-EF** ALSO AVAILABLE IN DIFFERENT SIZES

Wall log thickness 28 mm  
 Sizes (width / depth) 300 x 240 cm, 300 x 300 cm  
 Side wall height 190 cm  
 Max. height 247 cm  
 Roof overhangs (F/B/L/R) 40, 20, 20, 20 cm  
 Roof slope direction 20°  
 Doors ET 84 x 184 cm  
 Windows EF 75 x 92 cm

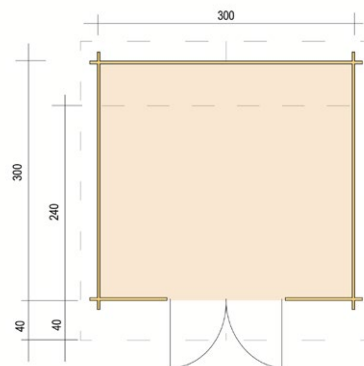

Object ID 659



**TS-H28-3024F-DT**

Wall log thickness	28 mm
Sizes (width / depth)	300 x 240 cm
Wall height (front)	207 cm
Wall height (back)	201 cm
Roof overhang (all around)	25 cm
Roof slope direction	1°
Doors	DT 142 x 184 cm
Windows	EF 100 x 40 cm

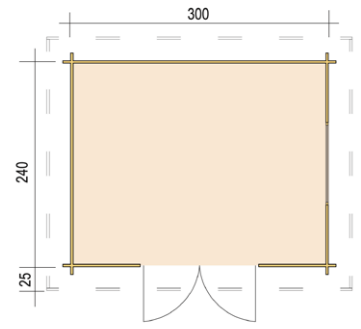

Object ID 68



**TS-H28AN-3924F-DT**

Wall log thickness	28 mm
Sizes (width / depth)	390 x 240 cm
Wall height (front)	207cm
Wall height (back)	201 cm
Roof overhang (all around)	25 cm
Roof slope direction	1°
Doors	DT 142 x 184; ET 84 x 184 cm
Windows	EF 100 x 40 cm

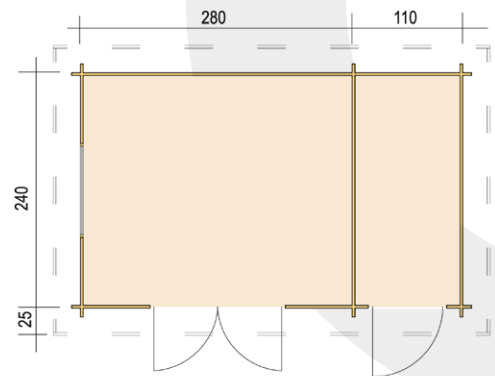

Object ID 69



**TS-H33-3630-DT-EF** ALSO AVAILABLE IN DIFFERENT SIZES

Wall log thickness	33 mm
Sizes (width / depth)	360 x 300 cm, 360 x 360 cm
Side wall height	194 cm
Max. height	257 cm
Roof overhangs (F/B/L/R)	70, 20, 25, 25 cm
Roof slope direction	20°
Doors	DT 142 x 184 cm
Windows	EF 75 x 92 cm

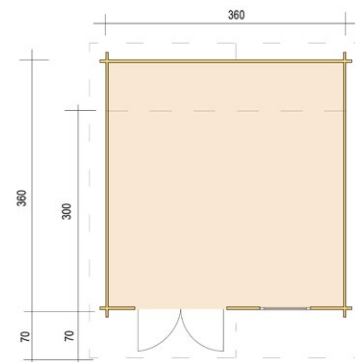

Object ID 71



**TS-H33-3939-DT-EF**

Wall log thickness	33 mm
Sizes (width / depth)	390 x 390 cm
Side wall height	194 cm
Max. height	263 cm
Roof overhangs (F/B/L/R)	70, 20, 25, 25 cm
Roof slope direction	20°
Doors	DT 142 x 184 cm
Windows	EF 75 x 92 cm

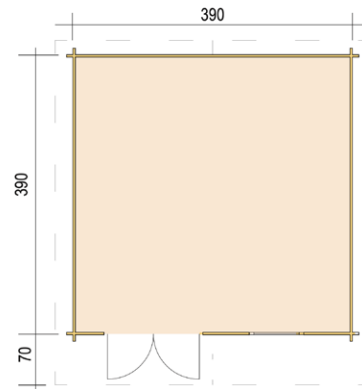

Object ID 73





**SHEDS**





**TS-H28-1921** ALSO AVAILABLE IN DIFFERENT SIZES

Wall log thickness	28 mm
Sizes (width / depth)	190 x 210 cm, 190 x 240 cm, 240 x 240 cm
Side wall height	190 cm
Max. height	224 cm
Roof overhangs (F/B/L/R)	30, 20, 20, 20 cm
Roof slope direction	20°
Doors	DT 130 x 184 cm

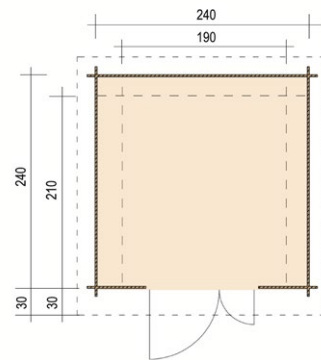

Object ID 60



**H28-2420-DT**

Wall log thickness	28 mm
Sizes (width / depth)	190 x 340 cm
Side wall height	190 cm
Max. height	224 cm
Roof overhangs (F/B/L/R)	30, 20, 15, 15 cm
Roof slope direction	20°
Doors	DT 130 x 184 cm

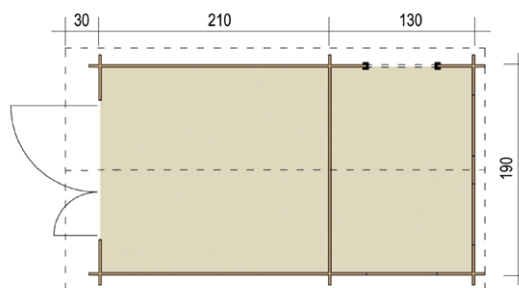

Object ID 63



**MHH-4030-F**

Wall log thickness 15 mm  
 Sizes (width / depth) 400 x 300 cm  
 Wall height (front) 246 cm  
 Roof slope direction 1°  
 Doors DT 150 x 194 cm  
 Windows 2 x EF 80 x 40 cm

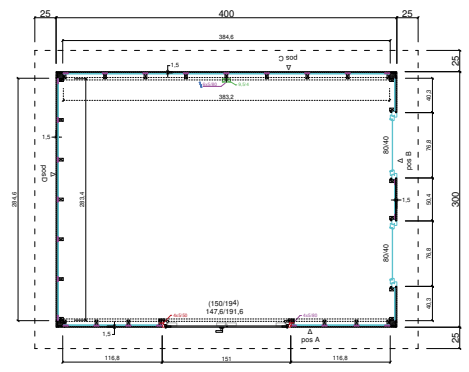

Object ID 1001



**TS-HL28-1221P** ALSO AVAILABLE IN DIFFERENT SIZES

Wall log thickness 28 mm  
 Sizes (width / depth) 120 x 210 cm, 120 x 240 cm  
 Wall height (front) 162,5 cm  
 Wall height (back) 173,5 cm  
 Sizes (width / depth) 15, 9, 9, 9 cm  
 Roof slope direction 5°

**LOG STORE (RIGHT OR LEFT)**

- HL28A-20**  
Wall log thickness: 28 mm, Depth: 200 cm
- HL28A-21**  
Wall log thickness: 28 mm, Depth: 210 cm
- HL28A-24**  
Wall log thickness: 28 mm, Depth: 240 cm
- HL28A-30**  
Wall log thickness: 28 mm, Depth: 300 cm

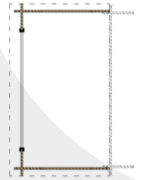
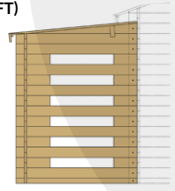

**Matching ring beams:**

- FR28-1220 / Floor\* and ring beams
- FR28-1221 / Floor\* and ring beams
- FR28-1224 / Floor\* and ring beams
- FR28-1230 / Floor\* and ring beams

**Matching guttering sets**

- 200B-b (brown) for FR28-1220/21
- 200B-b (brown) for FR28-1224
- 201Bx-b (brown) for FR28-1230

\* Floor with serrated boards 25 mm



Object ID 108



## TS-H28-2119-DT

Wall log thickness	28 mm
Sizes (width / depth)	210 x 190 cm
Side wall height	190 cm
Max. height	231 cm
Roof overhangs (F/B/L/R)	30, 20, 20, 20 cm
Roof slope direction	20°
Doors	DT 142 x 184 cm

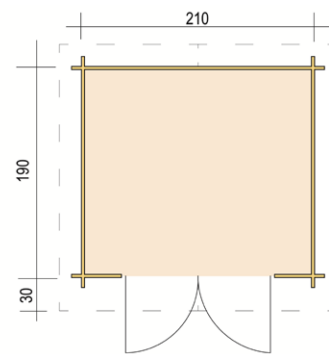

Object ID 64



## TS-H28-2119F ALSO AVAILABLE IN DIFFERENT SIZES

Wall log thickness	28 mm
Sizes (width / depth)	210 x 190 cm, 240 x 190 cm, 240 x 240 cm
Wall height (front)	207 cm
Wall height (back)	201 cm
Roof overhang (all around)	25 cm
Roof slope direction	2°, 1°, 1°
Doors	DT 130 x 184 cm

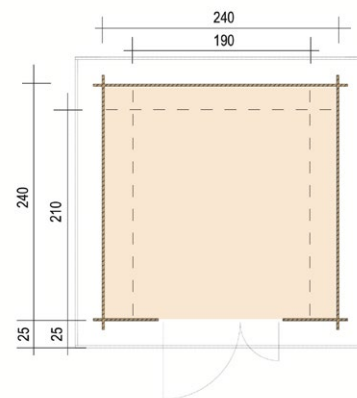

Object ID 57





## H28-2020-ET

Wall log thickness	28 mm
Sizes (width / depth)	200 x 200 cm
Side wall height	201 cm
Max. height	230 cm
Roof overhangs (F/B/L/R)	40, 20, 25, 25 cm
Roof slope direction	15°
Doors	ET 84 x 184 cm
Windows	EF 75 x 92 cm

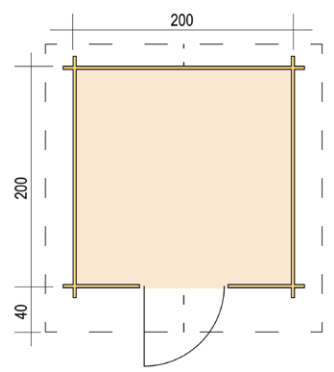

Object ID 74



## MHH-3025-CUBO

Wall log thickness	15 mm
Sizes (width / depth)	300 x 250 cm
Wall height (front)	234 cm
Roof slope direction	1°
Doors	T 125 x 200 (Frosted glass optional) cm
Windows	EF 100 x 40 (Frosted glass optional) cm

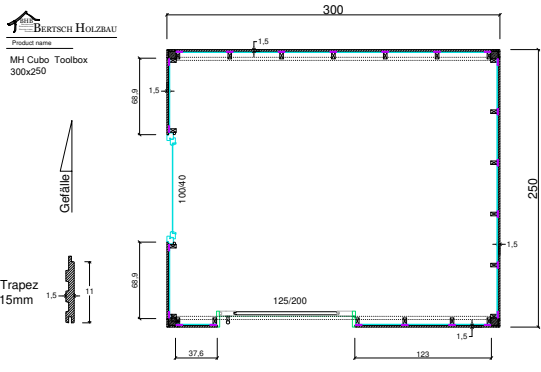

Object ID 1000



**HL28A-20** ALSO AVAILABLE IN DIFFERENT SIZES

Wall log thickness 28 mm  
 Sizes (width / depth) 120 x 200 cm, 120 x 240 cm, 120 x 300 cm  
 Roof shape Pent roof

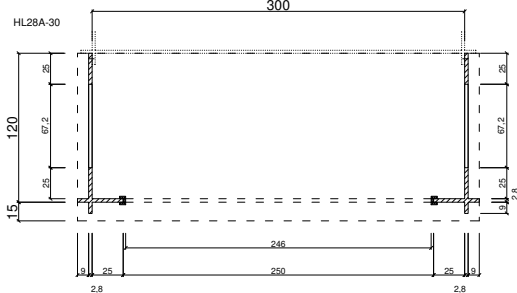

Object ID 675

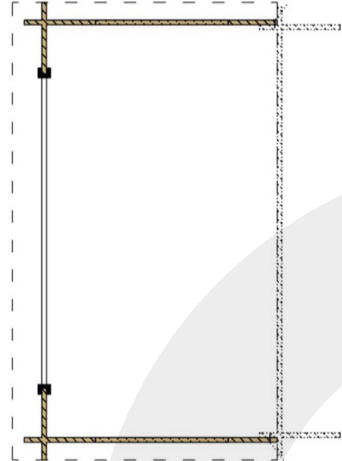
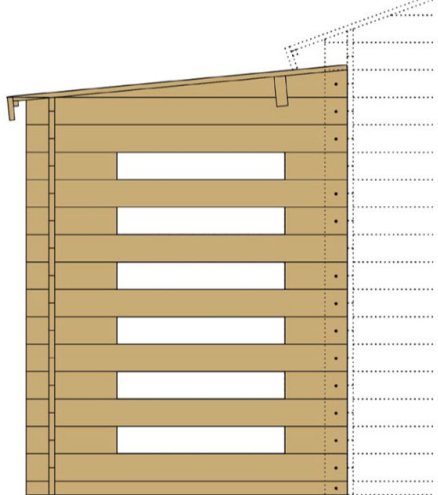

**BARTABLE**

Wall log thickness 240 x 240 cm  
 Roof shape Pent roof  
 Roof angle 15°

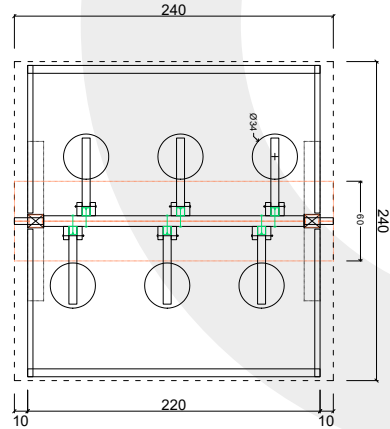

Object ID 742



# BIKE-BOX

Wall log thickness  
Sizes (width / depth)  
Roof shape

15 mm Softline  
215 x 150 cm  
Pent roof

BIKE-BOX  
150x215

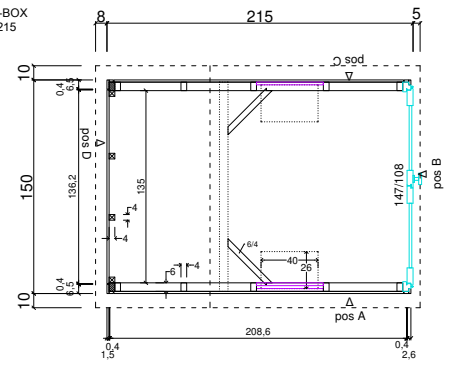

Object ID 2000

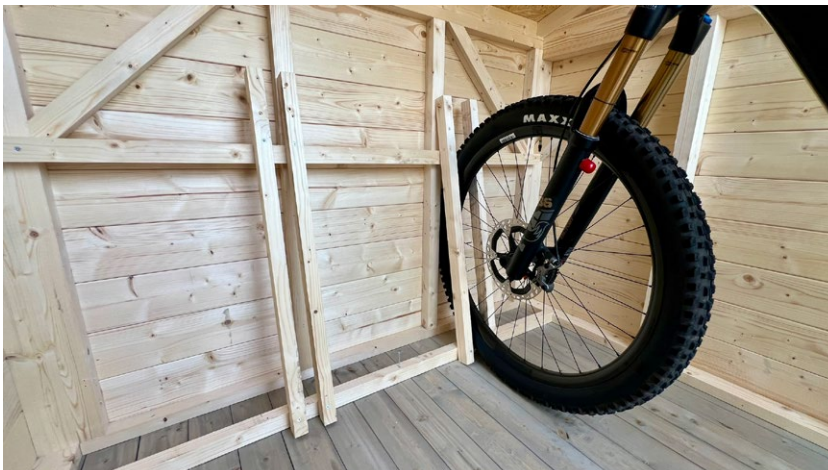



**GARDEN SAUNAS**





### H58-2227F+40VT-2ET-FF

Wall log thickness 58 mm  
 Sizes (width / depth) 220 x 279 + 40 cm  
 Side wall height 225 cm  
 Dachüberstand (V/H/L/R) 59, 20, 20, 20 cm  
 Dachneigung 1°  
 Türen 2 x ET 75 x 192 cm  
 Fenster FF 100 x 50 cm

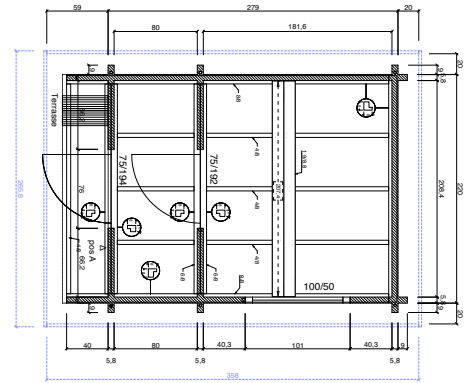

Object ID 1539



### H58-2240-2ET-EF-FF

Wall log thickness 58 mm  
 Sizes (width / depth) 220 x 400 cm  
 Side wall height 218 cm  
 Max. height 252 cm  
 Roof overhangs (F/B/L/R) 28, 20, 20, 20 cm  
 Roof slope direction 15°  
 Doors 2 x ET 75 x 192 cm  
 Windows FF 100 x 50 cm

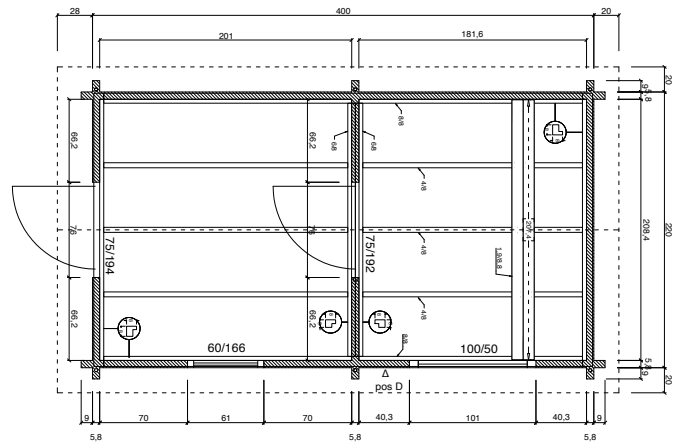

Object ID 1542



### H70-2240F-2ET-EF-FF

- Wall log thickness 70 mm
- Sizes (width / depth) 220 x 400 cm
- Side wall height 225 cm
- Roof overhangs (F/B/L/R) 28, 20, 20, 20 cm
- Roof slope direction 1°
- Doors 2 x ET 75 x 192 cm
- Windows FF 60 x 166, FF 100 x 50 cm

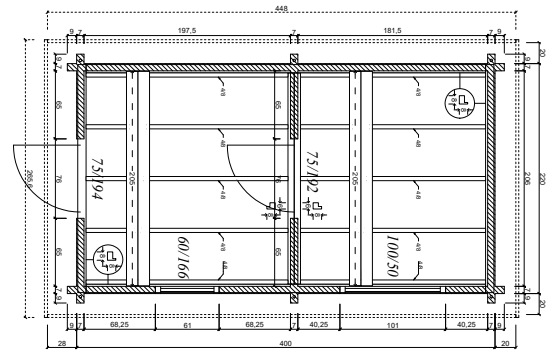

Object ID 1549



### H58-2227+40VT-2ET-FF

- Wall log thickness 58 mm
- Sizes (width / depth) 220 x 279 + 40 cm
- Side wall height 218 cm
- Max. height 252 cm
- Roof overhangs (F/B/L/R) 59, 20, 20, 20 cm
- Roof slope direction 15°
- Doors 2 x ET 75 x 192 cm
- Windows FF 100 x 50 cm

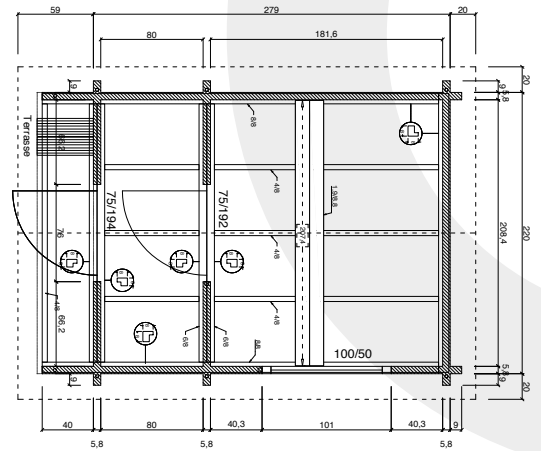

Object ID 1538



## H58-2231-2ET-FF

Wall log thickness 58 mm  
 Sizes (width / depth) 220 x 310 cm  
 Side wall height 218 cm  
 Max. height 252 cm  
 Roof overhangs (F/B/L/R) 28, 20, 20, 20 cm  
 Roof slope direction 15°  
 Doors 2 x ET 75 x 192 cm  
 Windows FF 100 x 50 cm

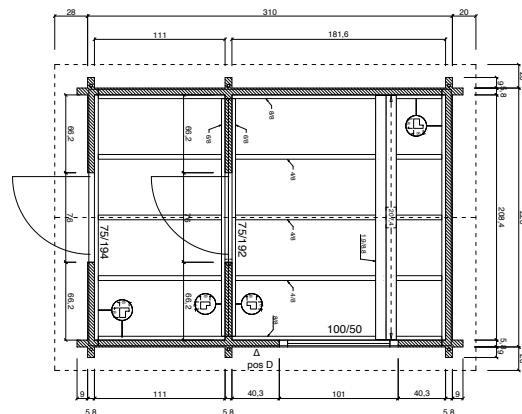

Object ID 1540



## H58-2231F-2ET-FF

Wall log thickness 58 mm  
 Sizes (width / depth) 220 x 310 cm  
 Side wall height 225 cm  
 Roof overhangs (F/B/L/R) 28, 20, 20, 20 cm  
 Roof slope direction 1°  
 Doors 2 x ET 75 x 192 cm  
 Windows FF 100 x 50 cm

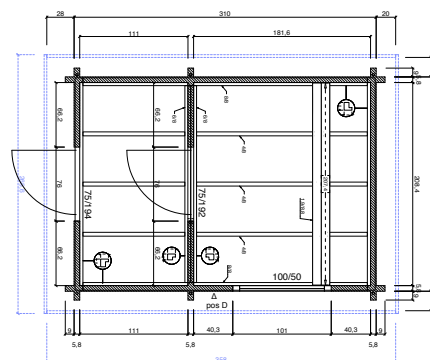

Object ID 1541



### H70-2227F+4OVT-2ET-FF

Wall log thickness	70 mm
Sizes (width / depth)	220 x 279 + 40 cm
Side wall height	225 cm
Roof overhangs (F/B/L/R)	59, 20, 20, 20 cm
Roof slope direction	1°
Doors	2 x ET 75 x 192 cm
Windows	FF 100 x 50 cm

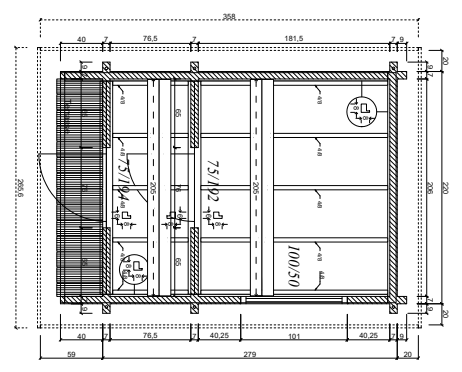

Object ID 1545



### H70-2231-2ET-FF

Wall log thickness	70 mm
Sizes (width / depth)	220 x 310 cm
Side wall height	218 cm
Max. height	252 cm
Roof overhangs (F/B/L/R)	28, 20, 20, 20 cm
Roof slope direction	15°
Doors	2 x ET 75 x 192 cm
Windows	FF 100 x 50 cm

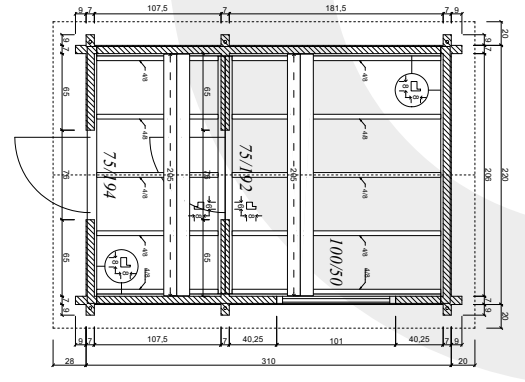

Object ID 1546



## H70-2240-2ET-EF-FF

Wall log thickness	70 mm
Sizes (width / depth)	220 x 400 cm
Side wall height	218 cm
Max. height	252 cm
Roof overhangs (F/B/L/R)	28, 20, 20, 20 cm
Roof slope direction	15°
Doors	2 x ET 75 x 192 cm
Windows	FF 60 x 166, FF 100 x 50 cm

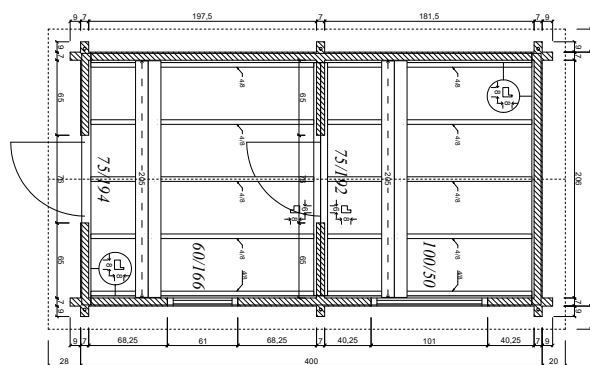

Object ID 1548



## H58-2240F-2ET-EF-FF

Wall log thickness	58 mm
Sizes (width / depth)	220 x 400 cm
Side wall height	225 cm
Roof overhangs (F/B/L/R)	28, 20, 20, 20 cm
Roof slope direction	1°
Doors	2 x ET 75 x 192 cm
Windows	FF 100 x 50 cm

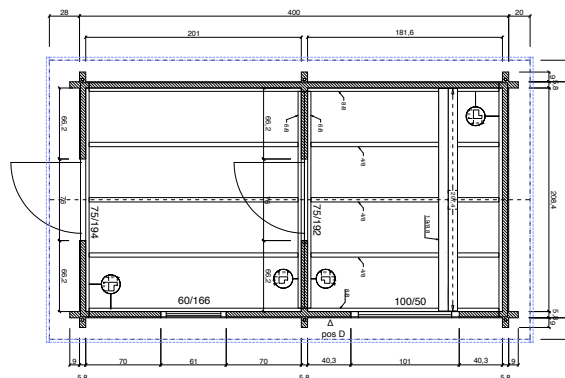

Object ID 1543





**CARPORTS**



## CPF-6054

Sizes (width / depth)	561 x 501 cm
Wall height (front)	251 cm
Wall height (back)	242 cm
Roof surface	32,4 m <sup>2</sup>
Roof overhang (all around)	19,5 cm
Roof slope direction	1°

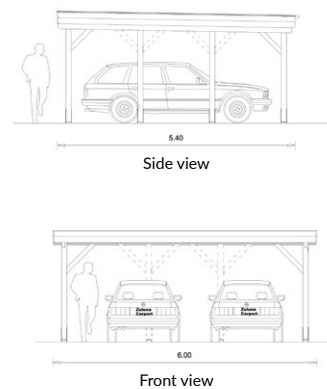
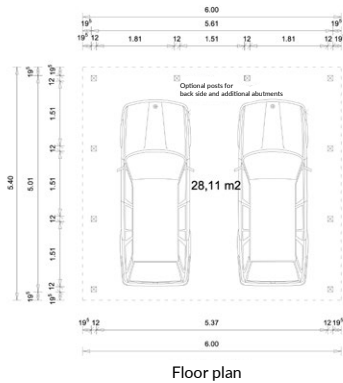

Object ID 104



## CPF-3854

Sizes (width / depth)	338 x 501 cm
Wall height (front)	245 cm
Wall height (back)	236 cm
Roof surface	20,4 m <sup>2</sup>
Roof overhang (all around)	19,5 cm
Roof slope direction	1°

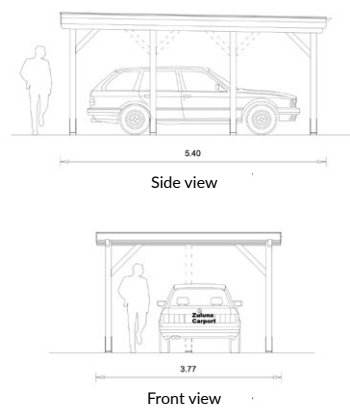
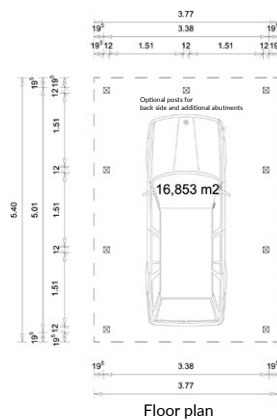

Object ID 103





**GAZEBOS**





**FS-3030** ALSO AVAILABLE IN DIFFERENT SIZES

Sizes (width / depth) 260 x 260 cm,  
 Side wall height 214 cm  
 Max. height 284 cm

Roof surface  
 Roof overhang (all around)  
 Roof slope direction

10 m<sup>2</sup>  
 20 cm  
 25 °



Object ID 105

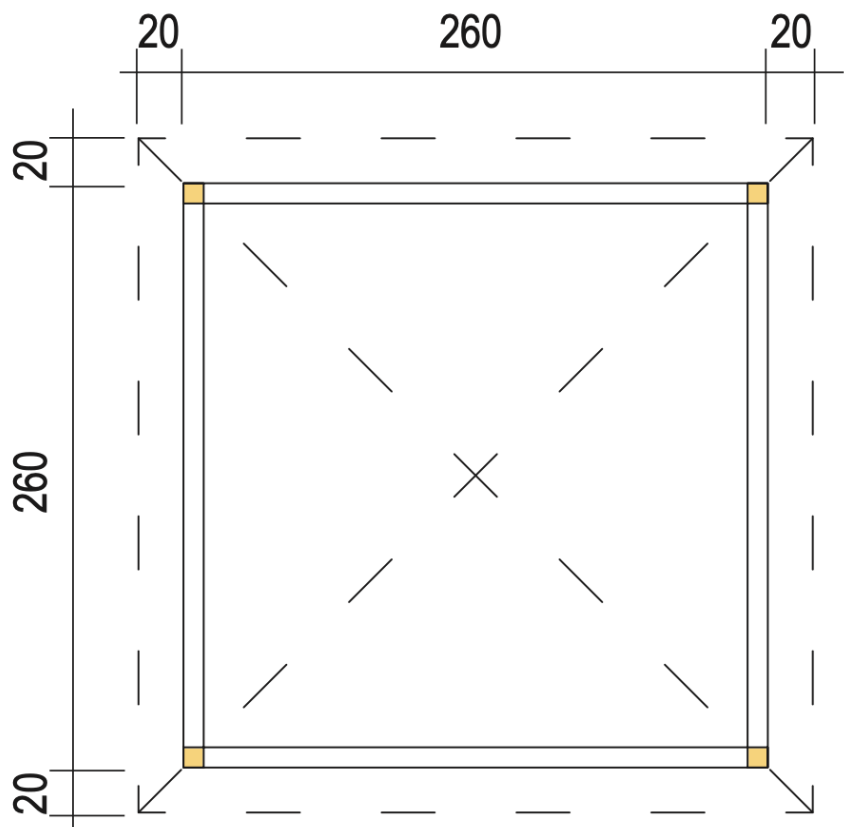



# SALES KIOSKS



## 123 KIOSK P

Wall log thickness 19 mm  
 Sizes (width / depth) 300 x 250 cm  
 Wall height (front) 245 cm  
 Wall height (back) 202 cm  
 Roof overhangs (F/B/L/R) 30, 15, 30, 30 cm  
 Roof slope direction 10°  
 Doors ET 79 x 181 cm

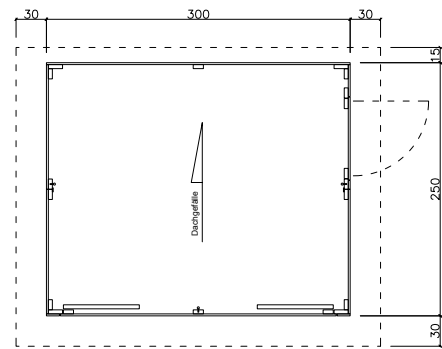

Object ID 53



## 123 KIOSK S

Wall log thickness 19 mm  
 Sizes (width / depth) 300 x 250 cm  
 Side wall height 206 cm  
 Max. height 265 cm  
 Roof overhangs (F/B/L/R) 30, 20, 30, 30 cm  
 Roof slope direction 18°  
 Doors ET 79 x 181 cm

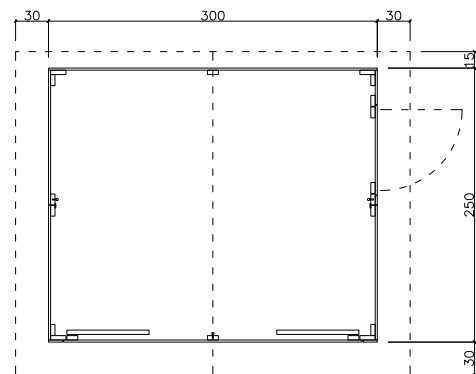

Object ID 54



**Possible side roofs for flat and pent roofs.**



**Side roof only, without walls**

<b>Sizes:</b>	<b>Article number:</b>
◦ 200 x 200 cm	◦ SD-F-28-2020
◦ 240 x 200 cm	◦ SD-F-28-2420
◦ 300 x 200 cm	◦ SD-F-28-3020
◦ 200 x 240 cm	◦ SD-F-28/-45-2024
◦ 240 x 240 cm	◦ SD-F-28/-45-2424
◦ 300 x 240 cm	◦ SD-F-28/-45-3024
◦ 200 x 300 cm	◦ SD-F-28-2030
◦ 240 x 300 cm	◦ SD-F-28-2430
◦ 300 x 300 cm	◦ SD-F-28-3030



**Back wall for side roof**

<b>Width:</b>	<b>Article number:</b>
◦ 200 cm	◦ RW-F-28/-45-R200
◦ 240 cm	◦ RW-F-28/-45-R240
◦ 300 cm	◦ RW-F-28/-45-R300



**Side wall for side roof (half height)**

<b>Depth:</b>	<b>Article number:</b>
◦ 200 cm	◦ SW-F-28-HG200
◦ 240 cm	◦ SW-F-28/-45-HG240
◦ 300 cm	◦ SW-F-28-HG300



**Side wall for side roof (half height)**

<b>Depth:</b>	<b>Article number:</b>
◦ 200 cm	◦ SW-F-28-GG200
◦ 240 cm	◦ SW-F-28/-45-GG240
◦ 300 cm	◦ SW-F-28-GG300

Side roofs can only be ordered together with the building, as they are an extension of the existing construction. Adjustable post anchors visible in the photo are available as an separately priced option.



### Side roof only, without walls

#### Sizes:

- 200 x 200 cm
- 240 x 200 cm
- 300 x 200 cm
- 200 x 240 cm
- 240 x 240 cm
- 300 x 240 cm
- 200 x 300 cm
- 240 x 300 cm
- 300 x 300 cm

#### Article number:

- SD-P-28-2020
- SD-P-28-2420
- SD-P-28-3020
- SD-P-28-2024
- SD-P-28-2424
- SD-P-28-3024
- SD-P-28-2030
- SD-P-28-2430
- SD-P-28-3030



### Back wall for side roof

#### Width:

- 200 cm
- 240 cm
- 300 cm

#### Article number:

- RW-P-28-R200
- RW-P-28-R240
- RW-P-28-R300



### Side wall for side roof (half height)

#### Depth:

- 200 cm
- 240 cm
- 300 cm

#### Article number:

- SW-P-28-HG200
- SW-P-28-HG240
- SW-P-28-HG300

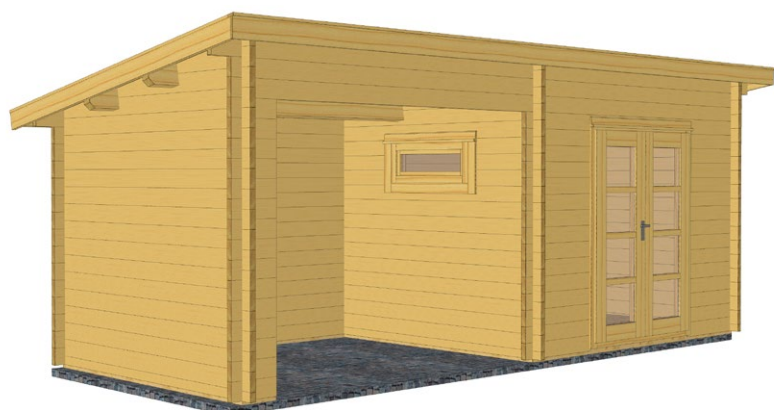

### Side wall for side roof (full height)

#### Depth:

- 200 cm
- 240 cm
- 300 cm

#### Article number:

- SW-P-28-GG200
- SW-P-28-GG240
- SW-P-28-GG300

Side roofs can only be ordered together with the building, as they are an extension of the existing construction. Adjustable post anchors visible in the photo are available as an separately priced option.

## Side roof

Left or right side

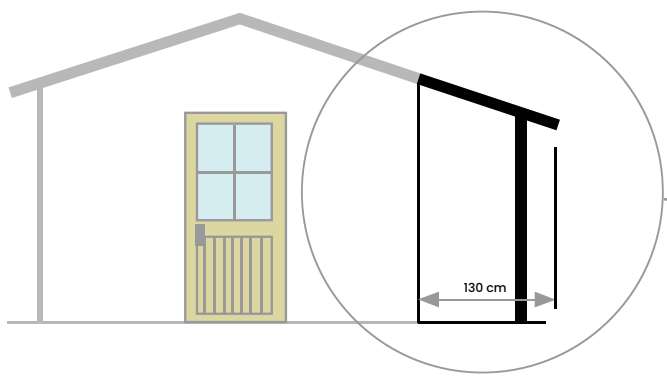

- **SD28-20**  
Wall log thickness: 28 mm, Depth: 200 cm
- **SD28-24**  
Wall log thickness: 28 mm, Depth: 240 cm
- **SD28-30**  
Wall log thickness: 28 mm, Depth: 300 cm
- **SD28-38**  
Wall log thickness: 28 mm, Depth: 380 cm
- **SD45-30**  
Wall log thickness: 45 mm, Depth: 300 cm
- **SD45-36**  
Wall log thickness: 45 mm, Depth: 360 cm
- **SD45-39**  
Wall log thickness: 45 mm, Depth: 390 cm
- **SD45-48**  
Wall log thickness: 45 mm, Depth: 485 cm

## Transport

We deliver ordered buildings via articulated lorries.  
 Please remember that the delivery place has to be reachable by a lorry up to **40 tonnes**,  
**4 m height**, **16,5 m in length** and **2,45 m width**.



## Couldn't find a building in our Zuluna range? Then please try our BHB Configurator, where you can design your own building!

In our BHB Configurator you can create a wide range of bespoke designs, like tool sheds, garden buildings, open pavilions, carports and garages.

After creating the design please contact a dealer of BHB products, who will present the price offer for you.

In case of designs which cannot be created in our configurator, we encourage you to contact a dealer of BHB products.

Our configurator is suitable for desktops and laptops, but is not optimized to work on smartphones and tablets.

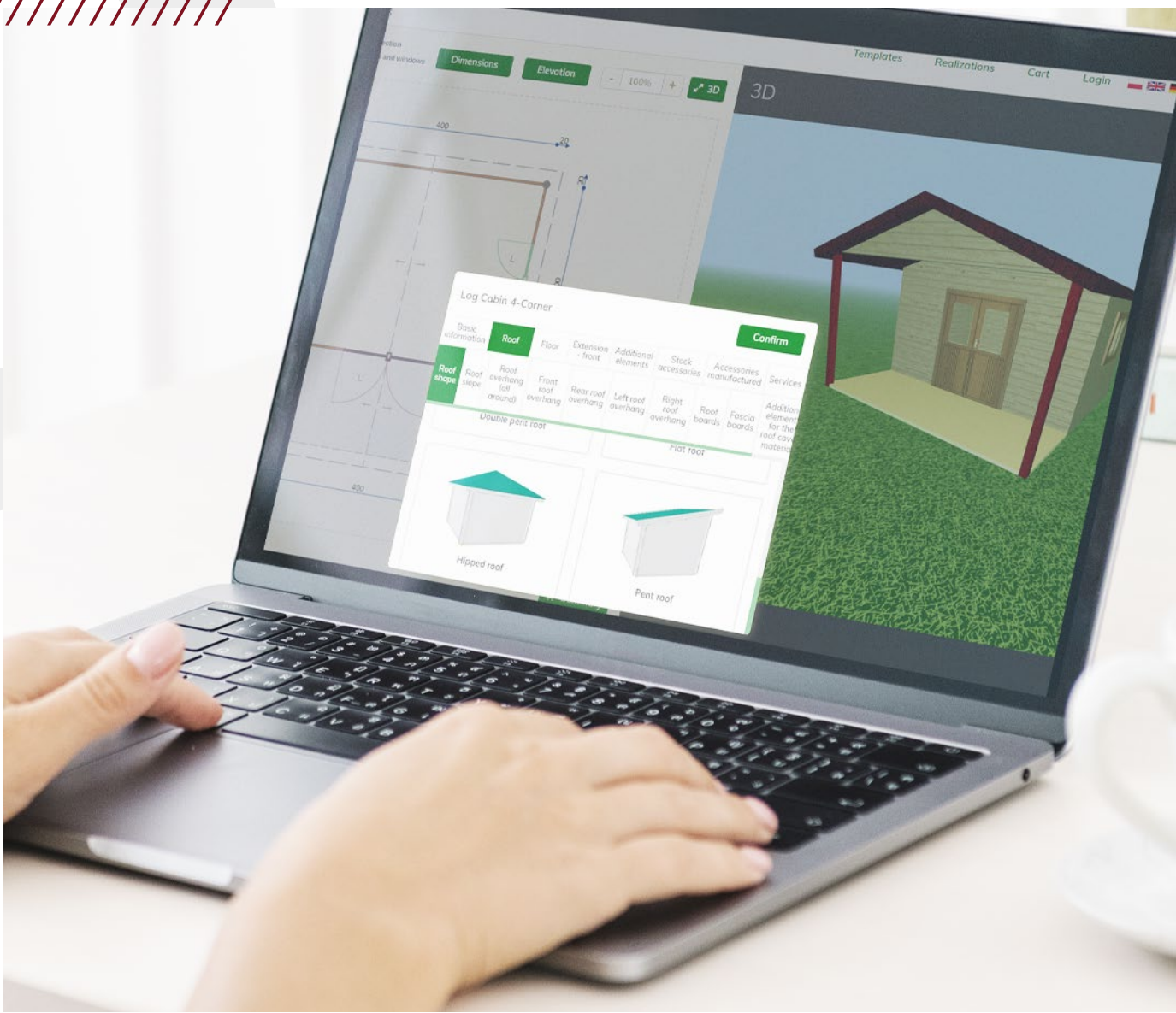
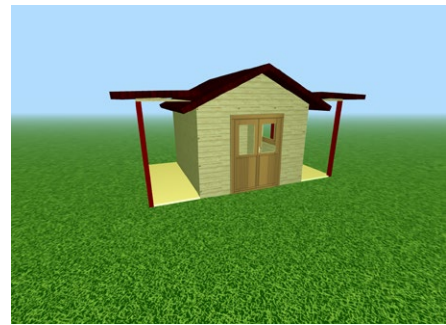
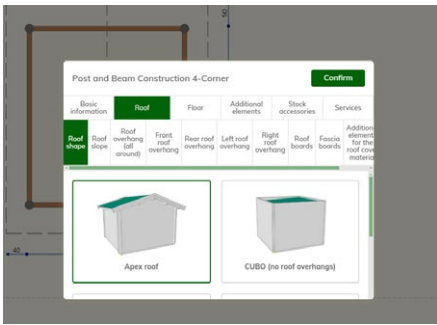
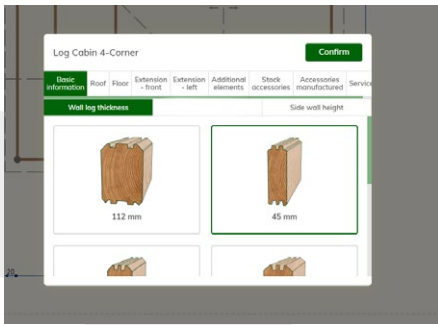

In standard version available only for log cabins.

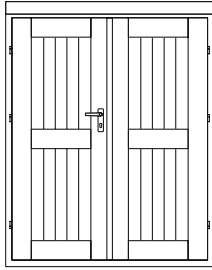
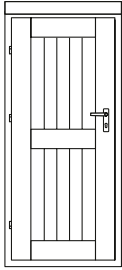

**T28-ET-GG**  
Wall thickness: 28mm  
Sizes: 84x184cm

**T28+-ET-GG**  
Wall thickness: 28mm  
Sizes: 84x194cm

**T45-ET-GG**  
Wall thickness: 45mm  
Sizes: 84x194cm

**T28-DT-GG**  
Wall thickness: 28mm  
Sizes: 150x184cm

**T28+-DT-GG**  
Wall thickness: 28mm  
Sizes: 150x194cm

**T45-DT-GG**  
Wall thickness: 45mm  
Sizes: 150x194cm

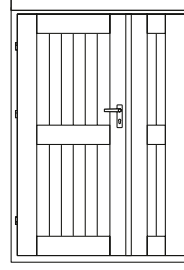

**TS28-DT-A**  
Wall thickness: 28mm  
Sizes: 130x184cm

**TS28+-D-A**  
Wall thickness: 28mm  
Sizes: 130x194cm

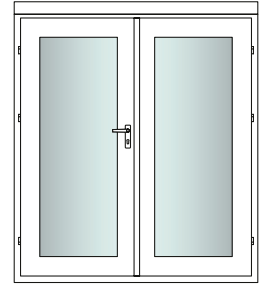

**T45-DT-GV1**  
Wall thickness: 45mm  
Sizes: 176x194cm

(changing doors is not possible)

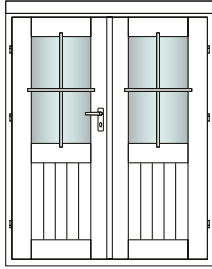
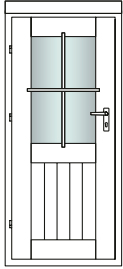

**T28-ET-GH**  
Wall thickness: 28mm  
Sizes: 84x184cm

**T28+-ET-GH**  
Wall thickness: 28mm  
Sizes: 84x194cm

**T45-ET-GH**  
Wall thickness: 45mm  
Sizes: 84x194cm

**TS28-DT-GH**  
Wall thickness: 28mm  
Sizes: 142x184cm

**TS28+-DT-GH**  
Wall thickness: 28mm  
Sizes: 142x194cm

**T28-DT-GH**  
Wall thickness: 28mm  
Sizes: 150x184cm

**T28+-DT-GH**  
Wall thickness: 28mm  
Sizes: 150x194cm

**T45-DT-GH**  
Wall thickness: 45mm  
Sizes: 150x194cm

**T28-ET-GA3**  
Wall thickness: 28mm  
Sizes: 84x184cm

**T28+-ET-GA3**  
Wall thickness: 28mm  
Sizes: 84x194cm

**T45-ET-GA3**  
Wall thickness: 45mm  
Sizes: 84x194cm

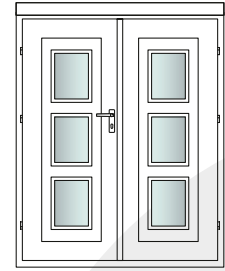
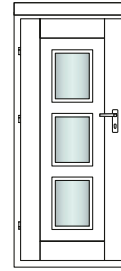

**T28-DT-GA3**  
Wall thickness: 28mm  
Sizes: 150x184cm

**T2s+-DT-GA3**  
Wall thickness: 28mm  
Sizes: 150x194cm

**T45-DT-GA3**  
Wall thickness: 45mm  
Sizes: 150x194cm

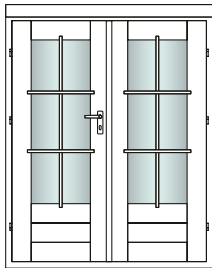
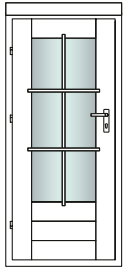

**T28-ET-GV3**  
Wall thickness: 28mm  
Sizes: 84x184cm

**T28+-ET-GV3**  
Wall thickness: 28mm  
Sizes: 84x194cm

**T45-ET-GV3**  
Wall thickness: 45mm  
Sizes: 84x194cm

**TS28-DT-GV3**  
Wall thickness: 28mm  
Sizes: 150x184cm

**TS28+-DT-GV3**  
Wall thickness: 28mm  
Sizes: 150x194cm

**T45-DT-GV3**  
Wall thickness: 45mm  
Sizes: 150x194cm

**T28-ET-GV1-QS**  
Wall thickness: 28mm  
Sizes: 84x184cm

**T28+-ET-GV1-QS**  
Wall thickness: 28mm  
Sizes: 84x194cm

**T45-ET-GV1-QS**  
Wall thickness: 45mm  
Sizes: 84x194cm

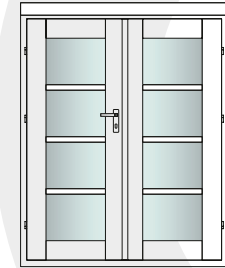
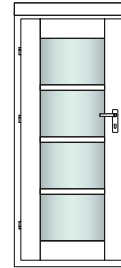

**T28-DT-GV1-QS**  
Wall thickness: 28mm  
Sizes: 150x184cm

**T2s+-DT-GV1-QS**  
Wall thickness: 28mm  
Sizes: 150x194cm

**T45-DT-GV1-QS**  
Wall thickness: 45mm  
Sizes: 150x194cm





In standard version available only for log cabins.

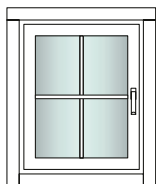

**F28-EF**  
Wall thickness: 28mm  
Sizes: 75x92cm

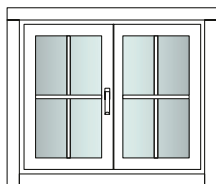

**F28-DF**  
Wall thickness: 28mm  
Sizes: 110x92cm

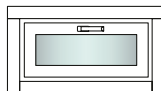

**F28-K80**  
Wall thickness: 28mm  
Sizes: 80x40cm

**F28-K100**  
Wall thickness: 28mm  
Sizes: 100x40cm

**F28-K125**  
Wall thickness: 28mm  
Sizes: 125x40cm

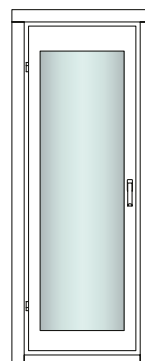

**F4S-EBF**  
Wall thickness: 45mm  
Sizes: 70x191,5cm

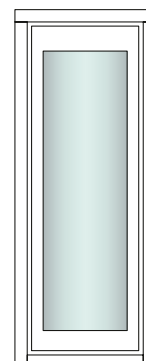

**F4S-EBF-FEST**  
Wall thickness: 45mm  
Sizes: 70x191,5cm

**F45-EF**  
Wall thickness: 45 mm  
Sizes: 75x92cm

**F45-DF**  
Wall thickness: 45mm  
Sizes: 110x92cm

**F45-K80**  
Wall thickness: 45mm  
Sizes: 80x40cm

**F45-K100**  
Wall thickness: 45mm  
Sizes: 100x40cm

**F45-K125**  
Wall thickness: 45mm  
Sizes: 125x40cm

Only for Zuluna buildings with pre-assembled walls.

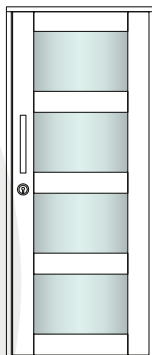

**MH-ST-S**  
Wall thickness: 15 mm  
Sizes: 84x200cm

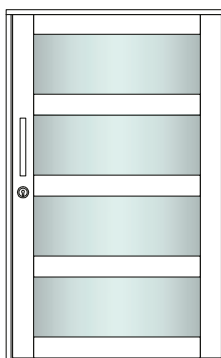

**NH-ST-B**  
Wall thickness: 15 mm  
Sizes: 125x200cm

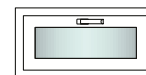

**NH-K80**  
Wall thickness: 15mm  
Sizes: 80x40cm

**NH-K100**  
Wall thickness: 15mm  
Sizes: 100x40cm

**NH-K125**  
Wall thickness: 15mm  
Sizes: 125x40cm

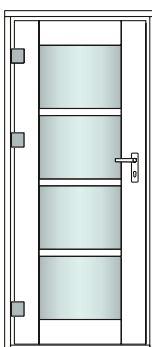

**NH-ET-GV1-QS**  
Wall thickness: 15mm  
Sizes: 84x194cm

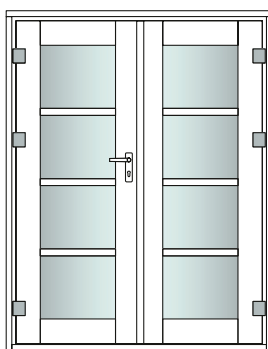

**NH-DT-GV1-QS**  
Wall thickness: 15mm  
Sizes: 150x194cm

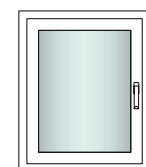

**MH-EF**  
Wandstärke: 15 mm  
Sizes: 75x92cm

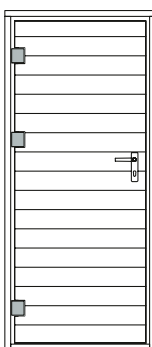

**MH-ET-GG-WB**  
Wall thickness: 15mm  
Sizes: 84x194cm

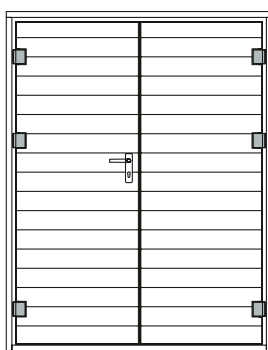

**MH-DT-GG-WB**  
Wall thickness: 15mm  
Sizes: 150x194cm

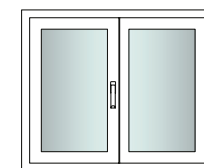

**MH-DF**  
Wall thickness: 15mm  
Sizes: 110x92cm



## Bitumen shingles

Order also shingles to protect your roof and building from weather conditions from the top. You can choose rectangle shingles in red, green, black, blue or brown colour or rounded shingles in either red or black.

### Rectangle shingles



R01 Red      R02 Green      R03 Black      R04 Blue      R05 Brown

### Rounded shingles

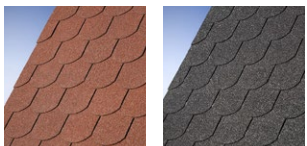

B01 Red      B02 Black



## EPDM sets

EPDM sets are optional accessories for all our flat roof models. EPDM set includes foil and two types of glue. Besides foil set, a downpipe F1 (up to 200 cm of side wall height) or F2 (for side walls higher than 200 cm). Every downpipe includes fixing elements, including inlet.



Variants of optional metal angles



Inlet

(only with U-shaped wooden fascia tops) for EPDM foil:

- RAL 7024 Graphite Grey
- RAL 9005 Deep Black
- RAL 8017 Choco Brown
- RAL 9006 White Aluminium

## Foundation construction

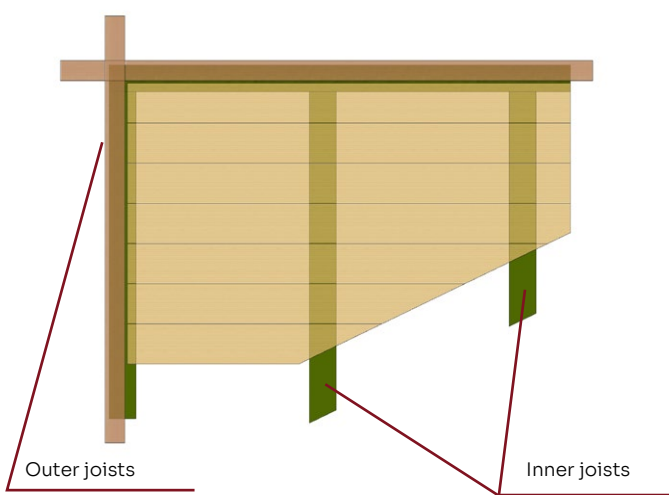

Foundation frame together with 19 mm floor boards

Wall thickness 28 mm  
Outer joists: 6/6 cm  
Inner joists: 6/4 cm

Wall thickness 45 mm  
Outer joists: 6/8 cm  
Inner joists: 6/4 cm

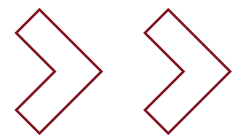

### Base Type 1

For buildings up to 380 cm x 380 cm

1. Mark the area and excavate to approx. 15-20 cm depth. The area should be 25 cm larger than the area of the building itself. Take into account the size of terraces and extensions.
2. Infill with gravel to a depth of approx. 10-12 cm. Compress the gravel to avoid movement.
3. Overlay with split gravel to a height of approx. 3-4 cm. Level the surface.
4. Lay the paving stones (approx. 4-5 cm high). Make sure these are level.
5. Place the pressure-treated joists 6/10 (or 8/14) cm. Make sure the timbers are at the same height. Take into consideration pipes for electric cables.

**ALL FOUNDATION TYPES HAVE TO BE PROTECTED FROM FROST**

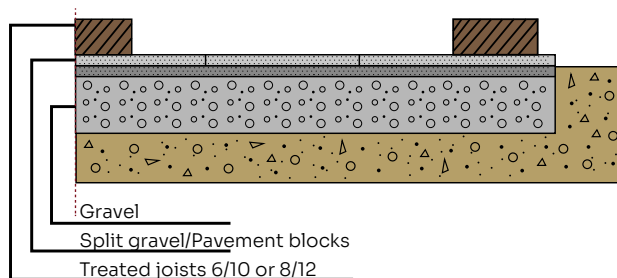

### Base Type 2

For buildings up to 400 cm x 400 cm

1. Mark the area and excavate to approx. 20 cm depth. The area should be 25 cm larger than the area of the building itself. Take into account the size of terraces and extensions.
2. Infill with gravel to a depth of approx. 7-10 cm. Compress the gravel to avoid movement.
3. Overlay with split gravel to a height of approx. 3-4 cm. Level the surface.
4. Lay the paving stones (approx. 4-5 cm high).
5. Place the pressure-treated joists 6/10 (or 8/14) cm. Make sure the timbers are at the same height.

Take into consideration pipes for electric cables.

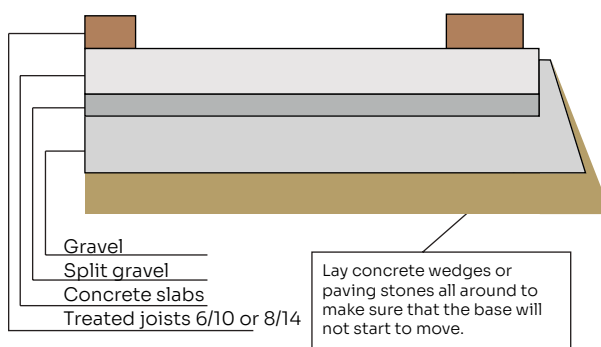

### Slab Foundation

1. Mark the area and excavate to approx. 15 cm depth. The area should be 25 cm larger than the area of the building itself. Take into account the size of terraces and extensions.
2. Infill with gravel to a depth of approx. 6 cm. Compress the gravel to avoid movement.
3. Overlay with split gravel to a height of approx. 3-4 cm. Level the surface.
4. Lay the paving stones (approx. 4-5 cm high). Place them horizontally.
5. Place the pressure-treated joists 6/10 (or 8/14) cm. Make sure the timbers are at the same height.

Take into consideration pipes for electric cables.

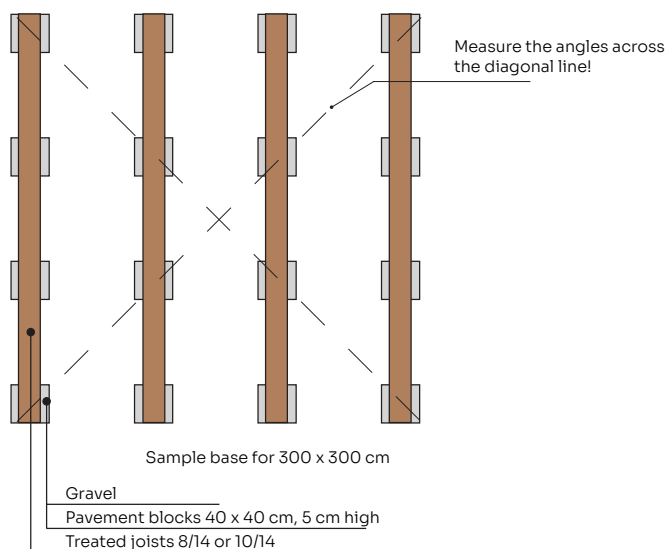

Dealer Address



Discover versatility and individuality  
of our products also on the Internet:

 [www.bertsch-holzbau.eu/zuluna](http://www.bertsch-holzbau.eu/zuluna)

 [zuluna\\_official](https://www.instagram.com/zuluna_official)

 [zulunabhb](https://www.facebook.com/zulunabhb)

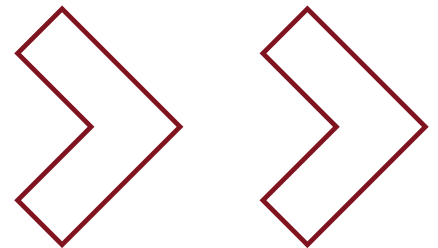

For comprehensive information about any of our products please contact your authorised dealer!  
Texts, photos and drawings in this brochure are subject to copyright. Unauthorised reproduction is forbidden, unless an explicit written permission is given. Colours shown in this brochure may deviate from the original colours due to printing. We reserve the right to make technical changes, mistakes and alterations of any model in the brochure. Reclamations for reasons as above will not be accepted. Images may display optional accessories, which are not included in the price of the model.

All models are standard ones and alterations are not possible. Drawings are not to scale. All models are delivered without treatment, without painting and without roof cover material.